

## Philips LPC2138 Target Board

|               |             |
|---------------|-------------|
| Ordering code | ITLPC2138   |
| Dimensions    | 100 x 96 mm |

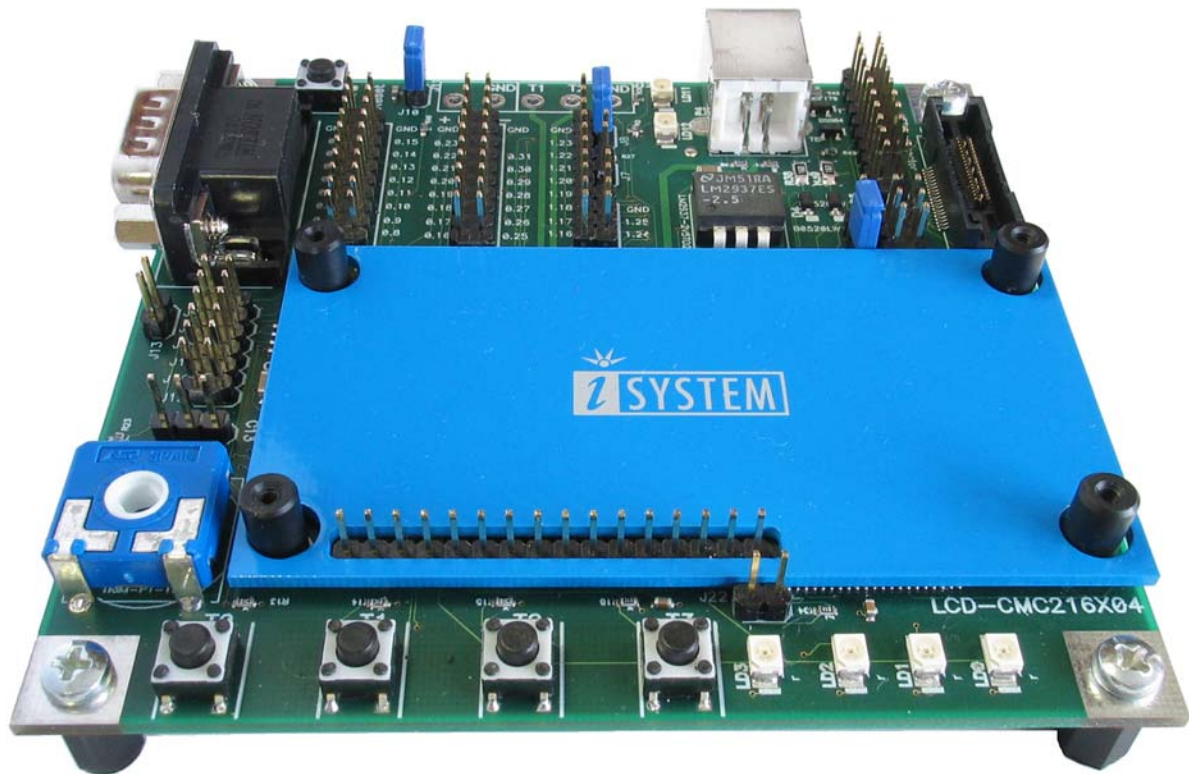

Figure 1: ITLPC2138 Target Board

## Contents

|  |    |
|--|----|
| Contents.....                                    | 2  |
| Introduction .....                               | 3  |
| Description .....                                | 3  |
| <i>View of the ITLPC2138</i> .....               | 3  |
| <i>Block Diagram</i> .....                       | 4  |
| <i>Components List</i> .....                     | 5  |
| <i>Power Supply</i> .....                        | 6  |
| <i>Jumper &amp; Connector Descriptions</i> ..... | 6  |
| <i>Connectors</i> .....                          | 7  |
| Schematic .....                                  | 10 |
| Licensing the on-board integrated debugger ..... | 11 |
| Use of the on-board integrated debugger .....    | 12 |
| Use of an external debugger.....                 | 13 |
| Troubleshooting .....                            | 14 |



## Block Diagram

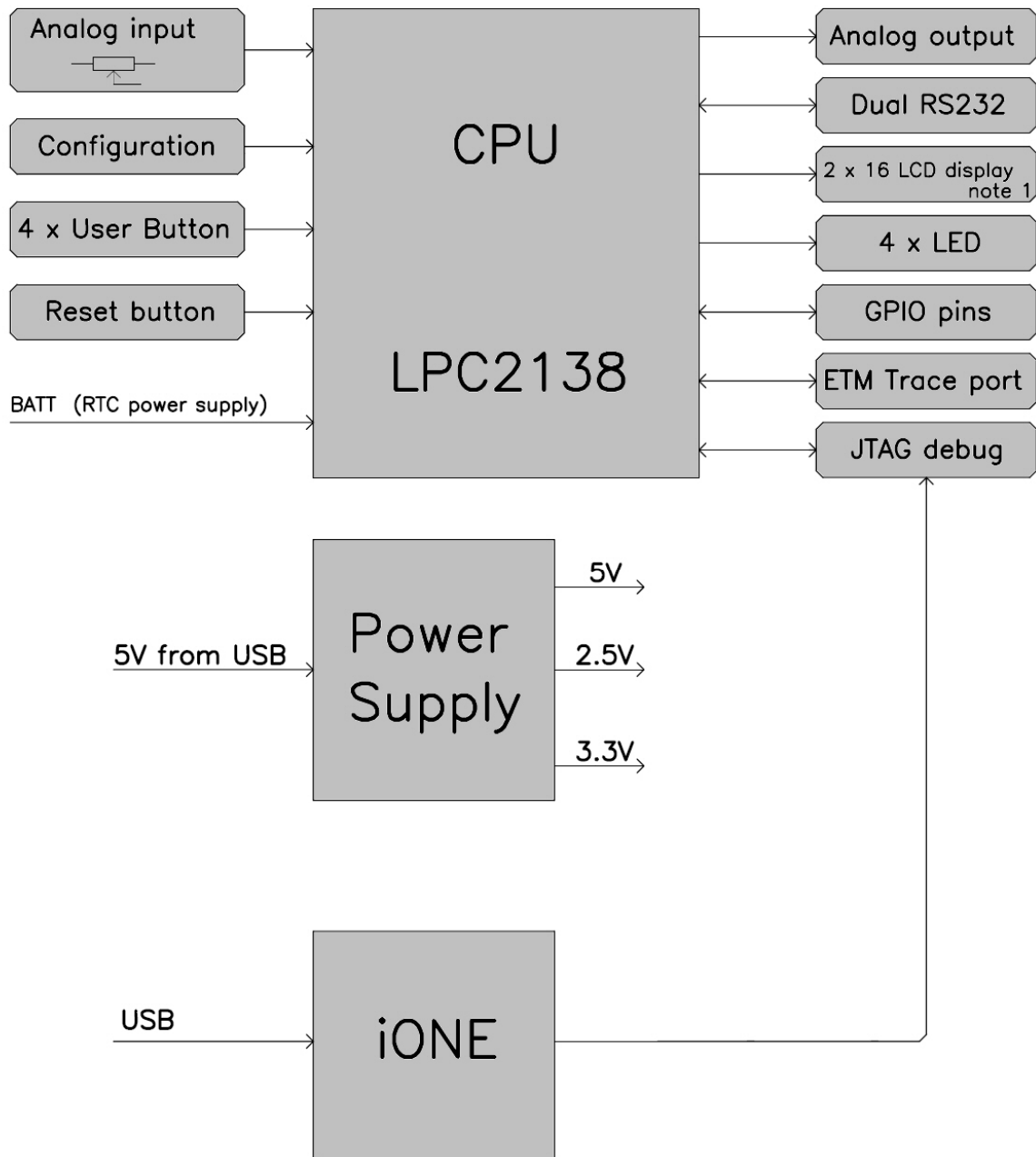

Figure 3: ITLPC2138 Block diagram

### Notes

1. The board provides 16-pin connector for the optional LCD display (type CMC216x04), which is not included in the package.

## Components List

| <b>Name</b>                   | <b>Description</b>                            |
|-------------------------------|---|
| P1                            | Connector for manufacturing purpose           |
| P2                            | ETM Trace connector                           |
| P3                            | JTAG debug connector                          |
| P4                            | USB connector (integrated debugger)           |
| P5                            | DB9 connector, serial port (UART1)            |
| J1                            | Expansion connector GPIO pins P0.0 – P0.7     |
| J2                            | Expansion connector GPIO pins P0.8 – P0.15    |
| J3                            | Expansion connector GPIO pins P0.16 – P0.23   |
| J4                            | Expansion connector GPIO pins P0.25 – P0.31   |
| J5                            | Expansion connector GPIO pins P1.16 – P1.23   |
| J6                            | Expansion connector GPIO pins P1.24 and P1.25 |
| J7 - J10, J15 – J20, J22, J25 | Jumpers                                       |
| J11                           | RTC power supply input (3.3V)                 |
| J12                           | Connector for manufacturing purpose           |
| J13                           | DA converter output                           |
| J14                           | Serial port (UART0)                           |
| J21                           | 16-pin LCD connector                          |
| LD0 – LD3                     | User LEDs                                     |
| LD11                          | Power LED 5V                                  |
| LD12                          | Power LED 3,3V                                |
| T0 – T3                       | Push buttons                                  |
| Reset                         | Reset button                                  |
| TRIM-PT                       | Trimmer potentiometer                         |

## Power Supply

The target board is powered from the PC USB port, through which winIDEA (IDE) running on a PC, connects to the on-board integrated debugger. Connection is made using a standard USB cable. Battery power supply for RTC can be optionally connected to J11 (see J11 description for more details).

## Jumper & Connector Descriptions

- **J7: Trace Port Enable:** J7 is set to enable pins P1.25:16 to operate as ETM Trace port after reset. Default not set.
- **J8: Debug Port Enable:** J8 is set to enable pins P1.31:26 to operate as a JTAG Debug port after reset. Default is set.
- **J9: Debug Mode:** J9 selects whether iSYSTEM on-board integrated USB-JTAG debugger is used or an external debug tool. Default set in position 1-2.\*
- **J10: RTC Power Supply Selector:** J10 connects Vbat pin of LPC2138 to the main 3.3V.
- **J11: RTC Power supply:** PCB terminal providing connection for battery. When battery power supply applied to J11 is used, J10 must be open.
- **J12: Manufacturing purpose connections**
- **J13: Analog Output:** J13 is analog output from OP amplifier, which connects to output of the DA converter.
- **J14: Serial Port (UART 0):** three pins connected to UART0. See connectors for more details.
- **J15: User LEDs Enable:** enables the LED driver connecting the on-board LEDs to GPIO P0.8 – P0.11.
- **J16: User Buttons Enable:** enables buttons driver connecting the on-board buttons to GPIO P0.12 – P0.15. Pushing the button generates a low signal. **If J16 is set, the CPU will not start in Boot-loader mode (see J25 description).**
- **J17: LCD Enable Signal:** connects GPIO P0.21 to the LCD enable pin.
- **J18: LCD R/W Signal:** connects GPIO P0.22 to the LCD R/W pin.
- **J19: Analog Output Enable:** connects DA converter output (GPIO P0.25) to the OP amplifier.
- **J20: Analog Input Enable:** connects the TRIM potentiometer to the analog input AD0.0 (GPIO P0.27).
- **J21: 16 Pin LCD Connector:** see connectors
- **J22: LCD LED Backlight Enable:** J22 is set to turn on LCD backlight.
- **J25: Startup mode** (populated on the bottom side of the target board): J25 connects either a pull-up (USER mode) or a pull-down (BOOT-loader mode) to P0.14. Default set in position USER (User mode). J16 must be removed when setting J25 in position BOOT, otherwise J25 setting is not effective.

\*Jumper pin 1 is marked with a white square on the ITLPC2138 PCB. If pin 1 cannot be located directly from the ITLPC2138, please use Figure 2 for assistance.

Note: Don't change jumper settings while the target board is supplied with power!

## Connectors

### DB9 male connector UART1 (P5)

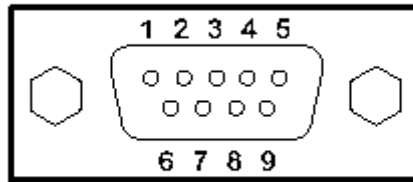

| Pin No. | Symbol |
|---------|--------|
| 2       | RxD    |
| 3       | TxD    |
| 5       | GND    |

The serial port is configured as a standard 3-wire interface. Cross female to female cable is needed for connection with PC computer COM port.

### 3-pin serial connector UART0 (J14)

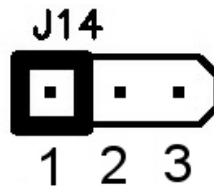

| Pin No. | Symbol |
|---------|--------|
| 1       | RxD    |
| 2       | TxD    |
| 3       | GND    |

The serial port is configured as a standard 3-wire interface.

## 16-pin LCD connector (J21)

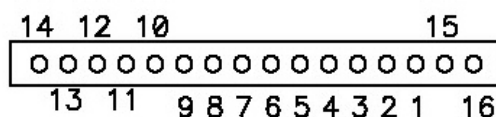

Top View

### Pin Assignment for Crystal Clear technology CMC216x04 LCD

| Pin No. | Symbol | Function                    |
|---------|--------|-----------------------------|
| 1       | GND    | Ground Terminal             |
| 2       | Vdd    | Supply Terminal             |
| 3       | Vo     | Power Supply for LCD Driver |
| 4       | RS     | Register Select Signal      |
| 5       | R/W    | Read/Write Selection        |
| 6       | E      | Enable Signal               |
| 7       | DB0    | Data Bus Line (Not used)    |
| 8       | DB1    | Data Bus Line (Not used)    |
| 9       | DB2    | Data Bus Line (Not used)    |
| 10      | DB3    | Data Bus Line (Not used)    |
| 11      | DB4    | Data Bus Line               |
| 12      | DB5    | Data Bus Line               |
| 13      | DB6    | Data Bus Line               |
| 14      | DB7    | Data Bus Line               |
| 15      | BL+    | LED Backlight Power Supply  |
| 16      | BL-    | LED Backlight Ground        |

## 20-pin JTAG Debug Connector (P3)

|           |    |    |      |
|-----------|----|----|------|
| Not used  | 1  | 2  | T3V3 |
| CPU_TRST  | 3  | 4  | GND  |
| CPU_TDI   | 5  | 6  | GND  |
| CPU_TMS   | 7  | 8  | GND  |
| CTCK      | 9  | 10 | GND  |
| Not used  | 11 | 12 | GND  |
| CPU_TDO   | 13 | 14 | GND  |
| CPU_RESET | 15 | 16 | GND  |
| Not used  | 17 | 18 | GND  |
| Not used  | 19 | 20 | GND  |

An external JTAG debug tool can be connected to a 20-pin P3 debug connector. Jumper J9 must be set to 2-3 position when using an external debugger.



## 38-pin Mictor JTAG Debug & ETM Trace Connector (P2)

| Signal    | Pin | Pin | Signal   |
|-----------|-----|-----|----------|
| Not used  | 1   | 2   | Not used |
| Not used  | 3   | 4   | Not used |
| GND       | 5   | 6   | TRACECLK |
| Not used  | 7   | 8   | Not used |
| CPU_RESET | 9   | 10  | Not used |
| CPU_TDO   | 11  | 12  | T3V3     |
| GND       | 13  | 14  | Not used |
| CTCK      | 15  | 16  | GND      |
| CPU_TMS   | 17  | 18  | GND      |
| CPU_TDI   | 19  | 20  | GND      |
| CPU_TRST  | 21  | 22  | GND      |
| GND       | 23  | 24  | P1.19    |
| GND       | 25  | 26  | P1.18    |
| GND       | 27  | 28  | P1.17    |
| GND       | 29  | 30  | P1.16    |
| GND       | 31  | 32  | P1.20    |
| GND       | 33  | 34  | P1.23    |
| GND       | 35  | 36  | P1.22    |
| GND       | 37  | 38  | P1.21    |

An external JTAG & ETM debug tool can be connected to a 38-pin Mictor P2 debug connector. Jumper J9 must be set to 2-3 position when using an external debugger.

## CPU expansion connectors

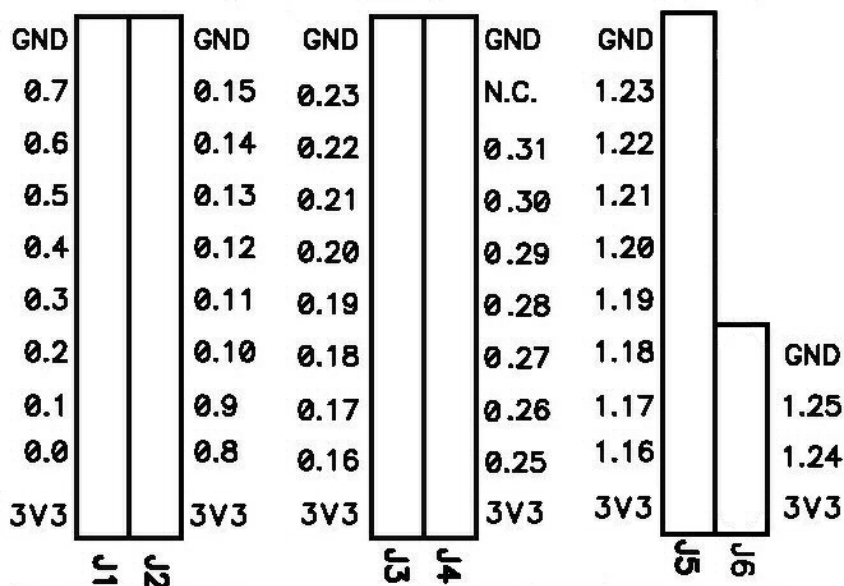

Figure 4: Expansion connectors

All CPU signals are available on the expansion connectors, which are standard connectors with a 2.54 mm raster.



## Licensing the on-board integrated debugger

A 30-days evaluation period starts after the debugger (winIDEA) connects to the ITLPC2138 for the first time. Within the evaluation period, the user should request a regular license from iSYSTEM. Run the request wizard to obtain the license INIT string by pressing the 'Request INIT...' button in the 'Hardware/Hardware/License' tab.

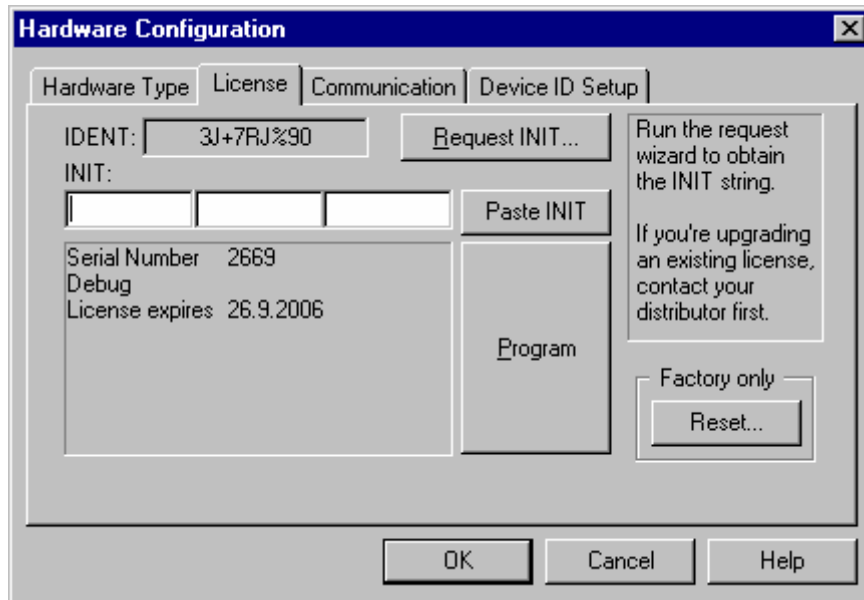

## ***Use of the on-board integrated debugger***

Follow below instructions, in order to get a sample application running with “out of the box” experience. All jumpers are set in the default position during the final tests in the manufacturing.

If winIDEA 2006 CD is not part of the package, please obtain winIDEA 2006 setup from your local iSYSTEM office or from [www.isystem.com](http://www.isystem.com).

- Install winIDEA 2006 (IDE) full setup on a PC
- Verify jumpers J15-J20 (see Jumpers description for their default position)
- Verify that jumper J8 is set
- Verify that jumper J7 is not set.
- Verify that jumper J9 is set in position 1-2 (on-board integrated debugger enabled).
- Open winIDEA 2006 application and open a sample workspace for the ITLPC2138 running from the internal flash.
- Connect the USB cable to the PC and to the ITLPC2138.
- Windows should auto-detect a new USB device and install belonging USB driver. In case of any problems, the driver is located under winIDEA install directory (e.g. c:\winIDEA\2006\USBDrv).
- Disconnect the USB cable from the ITLPC2138 and then connect it again. The two power LEDs should turn on. The target board is not powered if the LEDs don't lit and the problem needs to be resolved before proceeding to the next step!
- Finally, execute Debug/Debug Reset. This should initialize the development system and the user should be able to write to the internal CPU RAM through the memory window.
- Next, execute Debug/Download. This should program and run the application until main function. The development system is now ready for the debugging.

## ***Use of an external debugger***

An external debugger can be:

- a JTAG debugger, which connects to a 20-pin P3 connector
- a development tool supporting JTAG debugging and ETM (on-chip trace), which connects to a 38-pin Mictor P2 connector

### **Setting up a debug environment for the first time**

- Verify jumpers J15-J20 (see Jumpers description for their default position)
- Verify that jumper J8 is set
- Verify that jumper J7 is set if your development tool connects to P2
- Verify that jumper J9 is set in position 2-3 (on-board integrated debugger disabled)
- winIDEA 2006 application must be installed and run once in order to power the ITLPC2138 board through the USB connection.
- Connect the USB cable to the PC and to the ITLPC2138.
- Windows should auto-detect a new USB device and install belonging USB driver. In case of any problems, the driver is located under winIDEA install directory (e.g. c:\winIDEA\2006\USBDrv).
- Disconnect the USB cable from the ITLPC2138 and then connect it again. The two power LEDs should turn on. The target board is not powered if the LEDs don't lit and the problem needs to be resolved before proceeding to the next step!
- Disconnect the USB cable from the ITLPC2138 once again, connect the external development system to P2 or P3 (depending on the development system), turn it on and then connect back the USB cable.
- Execute a debug command equivalent to the CPU reset debug command. This should initialize the development system and the user should be able to write to the internal CPU RAM through the memory window. The development system should be now ready for use.

## ***Troubleshooting***

The flash boot loader code is executed every time the CPU is powered or reset. The loader can execute the ISP command handler or the user application code. P0.14 is sensed on a rising edge on the RST (CPU reset) pin. If a low level is detected, ISP command handler starts and takes over control of the CPU after reset. If there is no request for the ISP command handler execution (a high-level detected), a search is made for a valid user program. If a valid user program is found then the execution control is transferred to it. Refer to CPU User Manual for more details on CPU startup mode.

Normally, jumper J25 is set for 'User mode' by default. Boot-loader mode should be normally selected only for troubleshooting or when the user explicitly wants to use Boot-loader mode. J16 must be removed when Boot-loader mode is selected (see J16 description for more details).

There was a case, where the code was programmed in the flash, which disabled the JTAG debug port shortly after reset. Due to the Philips implementation, the debugger cannot take over control over the CPU immediately after reset, but a part of code is executed before the CPU can be stopped by the debugger. In this particular case, the application disabled JTAG port before the debugger took control over the CPU and the debugger could not connect to the CPU at all. Thereby, note that if the debugger cannot connect to the CPU (winIDEA reports "Cannot stop CPU"), it may be due to bad program in the flash. In this case, Boot-loader mode has to be selected (in order for the CPU to start executing ISP command handler), in which the debugger can always stop the program and take over control over the CPU. Then a new valid program can be programmed in the flash or flash erased. Then the User mode can be used again.

Notes:

---

Disclaimer: iSYSTEM assumes no responsibility for any errors which may appear in this document, reserves the right to change devices or specifications detailed herein at any time without notice, and does not make any commitment to update the information herein.

© iSYSTEM. All rights reserved.